

Data Sheet



Article number: 0125090

Description: Retaining ring SP85
Spring steel

Measures

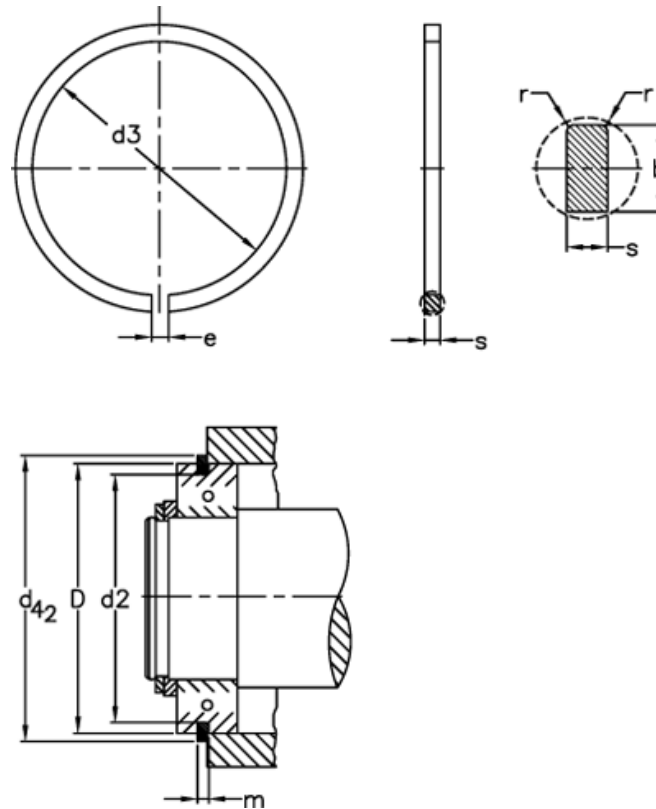

b	= 4.85	FRg kN	= 5.16	tol	= -0.15
D	= 85	FR kN	= 33.5	tol	= -0.1
d2	= 81.81	g	= 3.0	tol	= -0.50
d3	= 80.4	K kN-mm	= 60.5	tol	= 0.3
d42	= 91.6	m	= 1.90	tol	= 0.8
Description	= SP 85	n abl x 1000	= 3.0	Weight kg/1000	= 17.5
e	= 5	r min	= 0.6		
FN kN	= 70.0	s	= 1.70		